

Embedded Smart Microscope Camera

TE Series

User's Manual

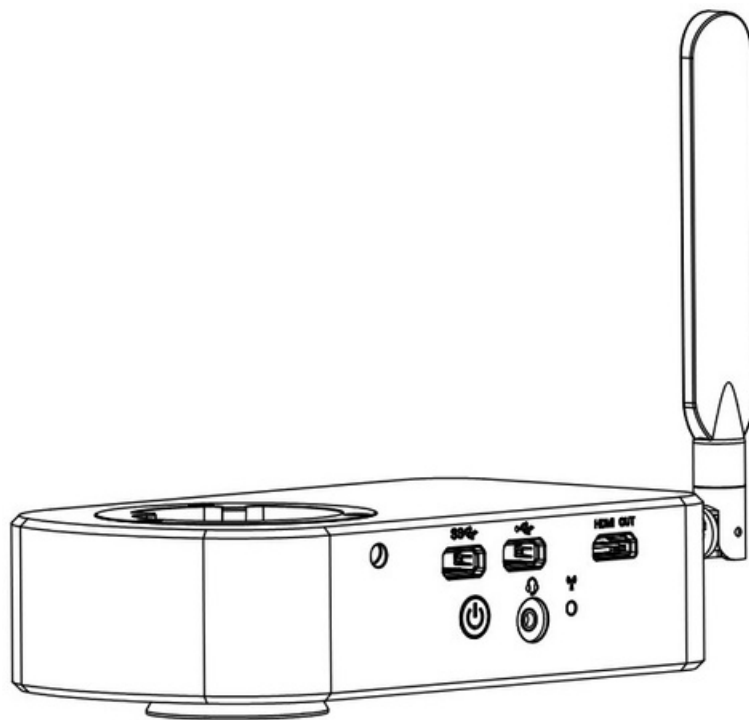

Content

CHAPTER 1 NOTES AND SAFETY REQUIREMENTS	- 1 -
1.1 CAUTIONS AND NOTES	- 1 -
CHAPTER 2 SOFTWARE SYSTEM REQUIREMENTS	- 2 -
2.1 SYSTEM REQUIREMENTS FOR CONNECTION TO PC WORK MODE	- 2 -
2.1 SYSTEM REQUIREMENTS UNDER HDMI WORKING MODE	- 2 -
CHAPTER 3 PACKING LIST	- 3 -
CHAPTER 4 FUNCTION INTRODUCTION OF EACH PART	- 4 -
4.1 NAME AND FUNCTION FOR EACH PART OF THE CAMERA	- 4 -
CHAPTER 5 PRODUCT ASSEMBLY GUIDE	- 5 -
5.1 SMART EMBEDDED CAMERA ASSEMBLY	- 5 -
5.1.1 Assembly with biological microscope	- 5 -
5.1.2 Disassembly the Camera	- 5 -
CHAPTER 6 INSTRUCTIONS	- 6 -
6.1 SOFTWARE INSTALLATION	- 6 -
6.2 DEVICE CONNECTION	- 6 -
6.2.1 WiFi working mode	- 6 -
6.2.2 HDMI working mode	- 6 -
6.3 METHOD OF PARFOCALIZING	- 7 -
6.4 START TO USE	- 7 -
CHAPTER 7 DISCLAIMER	- 8 -

Chapter 1 Notes and Safety Requirements

1.1 Cautions and Notes

- To avoid danger or damage incurred to the lens, do not touch the lens or sensor directly with your fingers.
- To avoid failure or electric shock hazard and so on, do not disassemble or modify the internal structure of the device.
- Do not plug in or unplug the Power connection port when hands are wet.
- Do not use alcohol and other organic solvents to clean.
- If the lens or sensor is dirty or damp, you should better use dry and non-linen fabric or professional lens tissue to wipe them. To avoid scratches on the surface, do not touch the lens with your fingers. Wipe the lens or sensor lightly.
- The products are not specifically designed for an outdoor use. Do not expose it to outdoor environment without any protection. Excessive temperature and humidity will damage the lens. Please avoid using the product under the following environment: high temperature or high humidity environment, places with direct sunlight, dirt or vibration and places near heat source.
- Please use and store in the following environment:
 - Operating temperature : 0°C~ 40°C
 - Storage temperature: -20°C~ 60°C
 - Operating Humidity: 30~60%RH
 - Storage Humidity: 10~80%RH
- If any foreign matter, water or liquid enter into the device by accident, disconnect the Power line immediately. Please send it to the maintenance center and do not use the hair dryer to dry it by yourself.
- To prevent microscope from being tripped over or dropped, please put away the device's connect cable in use or standby.
- To avoid electric shock by accident, please power off microscope before you move your computer or laptop.
- The cleanliness of the device lens will directly affect clarity degree of contents from the computer screen during preview. Problems like various circles or spots on the screen may mostly be incurred by dirt on the lens. When cleaning, please use professional lens tissue or other professional detergent to clear the dirt on the lens.
- Registered trademark and copyright: Copyright ownership of this produc belongs to Lanoptik Technologies Ltd. Without written authorization of this company, any organizations or individuals shall not photocopy, print, or translation to another language to any part of this document.

Chapter 2 Software System Requirements

2.1 System Requirements for connection to PC Work Mode

- Windows 7 (64bit), Windows 8 (64bit), Windows 8.1 (64bit), Windows 10 (64bit) , Windows 11 (64bit)
- Dual core 3.0GHz or higher CPU
- 8G or more memory
- At least 10 GB available hard-disk space
- 1000Mbps/100Mbps compatible with network cable interface

2.2 System Requirements for HDMI Work Mode

- The monitor has an HDMI TYPE A interface.
- The display supports up to 3840x2160 P60 output
- Display HDMI interface support hot plug

2.3 System Requirements under WiFi Work Mode

- 5.0 or above version for Android system.
- 8.0 or above version for IOS system.
- Wireless network hardware must support the 802.11ac protocol (5G WiFi mode).

Chapter 3 Packing List

- Embedded Smart Camera

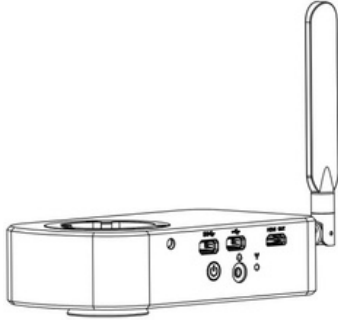

- 2.Hexagon Key



- Mouse & Keyboard Suite

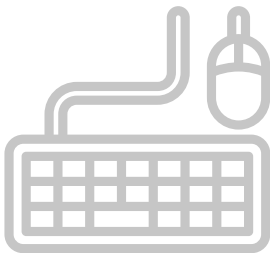

- 12V AC Adapter

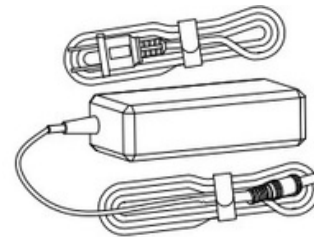

- Network Cable



- HDMI Cable

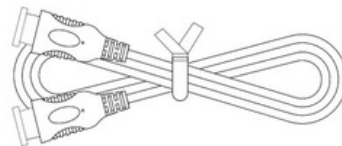

Chapter 4 Function Introduction of Each Part

4.1 Name and Function for Each Part of the Camera

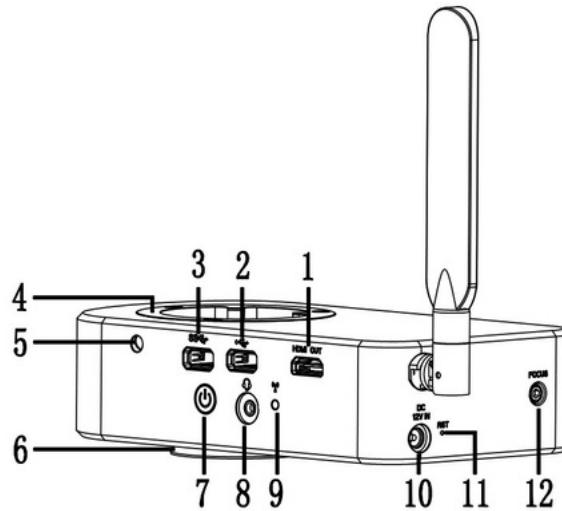

1. **HDMI interface:** connect with the display device with HDMI interface through HDMI cable to realize video and signal transmission.
2. **USB 2.0 interface:** can be connected to a mouse, keyboard, USB flash disk. Convenient for using Application .
3. **USB 3.0 interface:** can be connected to a mouse, keyboard, USB flash disk. Convenient for using Application .
4. **Female interface:** connected with the eyepiece end of biological microscope.
5. **Fastening screws:** tighten the screws with the hexagon key to fix the eyepiece end of the biological microscope.
6. **Male interface:** it is connected with the objective lens end of biological microscope.
7. **Power on/off:** 1) after being electrified, press for 3 seconds to start the camera; 2) after the camera is started, long press for 3 seconds to prompt the "shutdown/restart" option; 3) after starting the camera, press the button for 5 seconds to shut it down.
8. **Headset interface:** connect with headset cable to realize the mutual transmission of audio signals.
9. **Signal indicator light:** 1) When the camera is started: there is signal transmission, the indicator light flashes; When no mobile device is connected indicator light is always on; 2) When the camera is off: the indicator light is not on.
10. **Power input port:** connect with the adapter in the accessories to supply power to the smart embedded eyepiece
11. **Reset hole:** press for 8 seconds to reset the system.
12. **Focusing screw:** turn the screw with hexagonal key to adjust the focal length.

Chapter 5 Product Assembly Guide

5.1 Camera Assembly

5.1.1 Assembly with biological microscope

1. Take out the dust cover of the trinocular microscope, as shown in figure 5-5-1:

- 1) Loosen the fixing screw of the dust cover of the trinocular microscope;
- 2) Take out the dust cover of the microscope dovetail slot.

2. Camera installation

- 1) Place the camera to the dovetail slot of the microscope, as shown in figure 5-5-2;
- 2) Tighten the fastening screw on the microscope dovetail slot and fix the camera on the microscope.

3. Microscope eyepiece tube installation

- 1) The microscope eyepiece head is inserted into the master interface of camera, as shown in figure 5-5-3;
- 2) Tighten the fastening screws of the camera; and fix the eyepiece head of microscope.

4. The adapter interface is inserted into the display power hole. Connect the adapter to 110-240V AC.

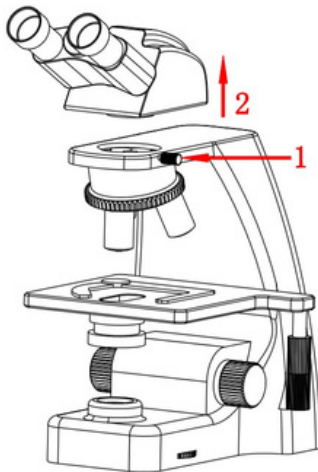

Figure 1

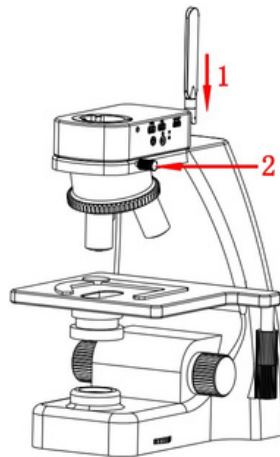

Figure 2

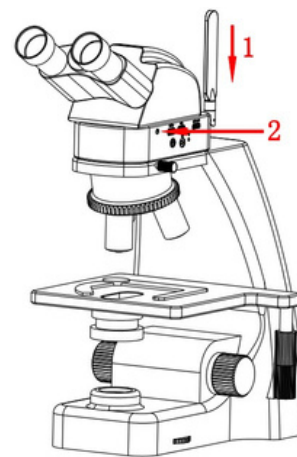

Figure 3

5.1.2 Disassembly the Camera

1. Reverse the assembly sequence

Chapter 6 Instructions

6.1 Application installation for smart devices

Use the smart terminal device to scan the QR code of the student camera and download and install [KoPa WiFi Lab] as prompted.

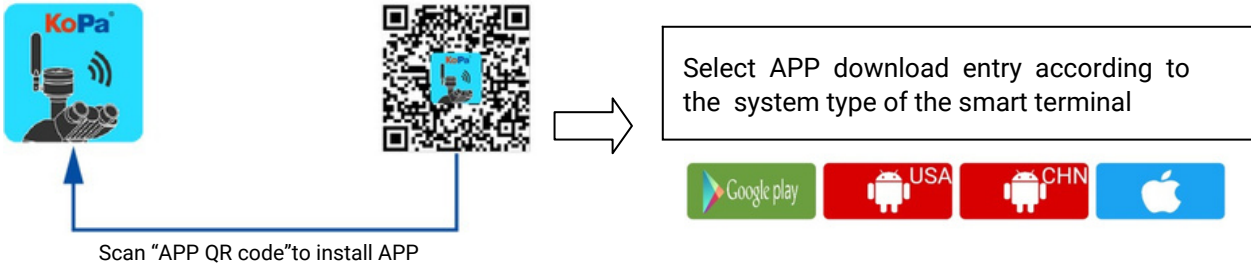

After the APP download is complete, follow the prompts to allow installation and allow all authorizations. Clicking "Not Allowed" will result in an inability to connect properly.

For Android users, if you can log in to the Google App Store, you can click one of the two buttons   to download.

For Android users in mainland China, please click the  button to download.

iOS system users please click the button  to download

6.2 Device Connection

6.2.1. WiFi Connection

Method 1: Automatic connection to mobile devices via scan QR code

- 1) Mount the camera to the microscope: refer to "Chapter 5",
- 2) Power the camera
- 3) Run "KoPa WiFi Lab"APP,
- 4) Click the "scan" icon in the App and scan the WiFi QR code on the top of camera to preview image,
- 5) Please refer to [User Manual of KoPa WiFi Lab] for detailed operation.



Method 2: Manually connect to mobile devices by entering a password

- 1) mounting the camera to a microscope: refer to "Chapter 5"
- 2) power the camera
- 3) search for the following WiFi signal in the Settings of the mobile device and enter the password
WiFi name: WiFiCamera_5G_XXXXXX;
Default Password: 12345678
- 4) Run "KoPa WiFi Lab" APP and click the preview icon of the APP to display image.
- 5) Please refer to [User Manual of KoPa WiFi Lab] for detailed operation.

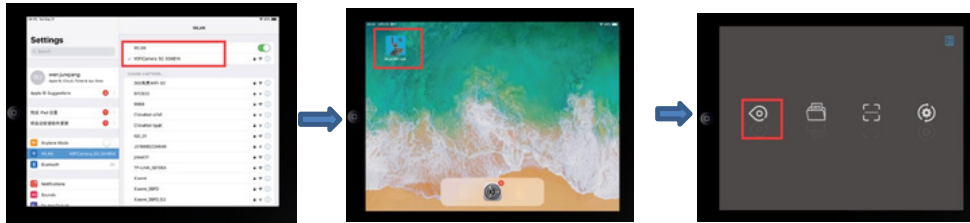

6.2.2 HDMI Connection

1. mounting the camera to a microscope: refer to "Chapter 5"
2. connect the camera with the display device with HDMI cable, and turn on the HDMI display device.
3. power the camera
4. Plug a mouse to the USB port.
5. Long press the power switch on the camera for 3 seconds to activate the camera
6. The camera is started normally. Please refer to the [User Manual of KoPa WiFi Lab AO] for detailed operation.

6.3 Method of Parfocalizing

1. Place the specimen on the loading platform of the microscope, adjust the eyepiece diopter to the minimum value, and use the 10X objective lens. It is recommended to use any black spot/or the darkest point on the focusing section under visual observation to be the clearest.
2. Use the allen key to turn the focusing screw and adjust the focal length until the image from software is clear.

6.4 Start to Use

The camera is ready for use now

Chapter 7 Disclaimer

1. In order to protect the legitimate rights and interests of users, please carefully read the instructions, disclaimers and safety instructions provided with this product before using it. The company reserves the right to update the above documents. Please operate the product according to the instructions and safety instructions.

2. Once you begin to use the product, you shall be deemed to have read, understood, recognized and accepted all terms and contents of the product's instructions, disclaimers and safety instructions. Users undertake to be responsible for their actions and all consequences. User undertakes to use the product only for legitimate purposes and agrees to these terms and any relevant policies or guidelines that the company may establish.

3. In the process of using this product, please strictly abide by and execute the requirements including but not limited to the instructions and safety instructions. All personal injuries, accidents, property losses, legal disputes and other adverse events that cause conflicts of interest caused by violation of the safety instructions or irresistible factors shall be borne by users themselves, and the company shall not assume any responsibility.

4. Safety instructions:

- Please do not use wet hands to plug and unplug the power supply of the equipment.
- Please be sure to use a regular brand power socket, and make sure the grounding is well grounded to prevent electric shock.
- Please be sure to make regular safety checks on sockets and plugs to avoid potential electrical safety hazards caused by aging and short circuit.
- Please be sure not to use the product in a humid or hot environment to ensure the safety of the product.
- Please be sure to loosen bundle cords of the power cable before using, to avoid electromagnetic induction and heating, thus increasing the heat dissipation speed.
- Please be sure not to use the product equipment or socket or other places in high or easy to fall, so as to avoid damage.
- Before opening the socket power supply, please be sure to turn off the load power switch of the product equipment.
- The company reserves the rights to improve product, upgrade technology and change parameters without prior notice.

Specifications are subject to change without any obligation on the part of the manufacturer.



LANOPTIK TECHNOLOGIES LTD

No. 72 Hongjing Street, Lejia Road, Baiyun District, Guangzhou, China. 510400

Phone: +86 20 3898 6017 | Fax: +86 20 3847 6076

Website: <http://www.lanoptik.com> | Email: info@lanoptik.com